



SELECTIVE PALLET RACK



General Characteristics of Selective Pallet Rack

Combining vertical frames with horizontal load beams, Interlake Mecalux Selective Pallet Rack provides total accessibility to the product. Both popular and durable, this racking system provides versatility for warehouses that have wide varieties of product types. It is manufactured from high-strength steel and other quality raw materials, which are certified to meet our stringent specifications.

Interlake Mecalux Selective Pallet Rack is roll formed and available with bolted or welded frame configurations. Beams are mounted to the frame and held in place with a piston lock connector. This allows the beams to be seated securely without the risk of accidental disengagement and enables easy arrangement when necessary.

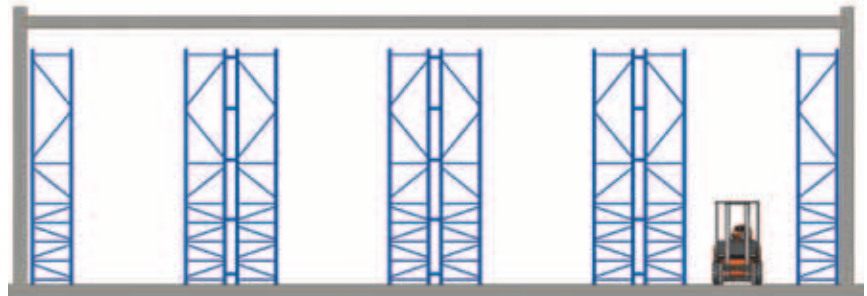

Single deep Selective system

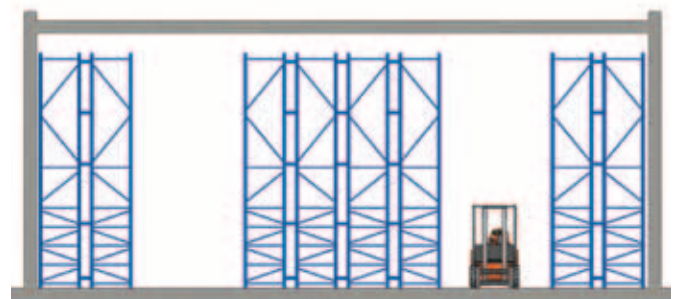

Double deep Selective system

Layout options within the Selective Pallet Rack system

You will want to choose between a single and a double deep system configuration by first determining the variety of SKUs being stored. High volumes of a limited number of products will more likely require a double deep system that has enough capacity to store two pallets deep by reducing the number of forklift access points. The double racking or back to back racking of the single deep system is designed to allow forklifts easier access to a larger number of SKU's stored at half the pallet depth. With either system, you'll want to utilize a forklift with the weight and reach capacity appropriate to your storage application.

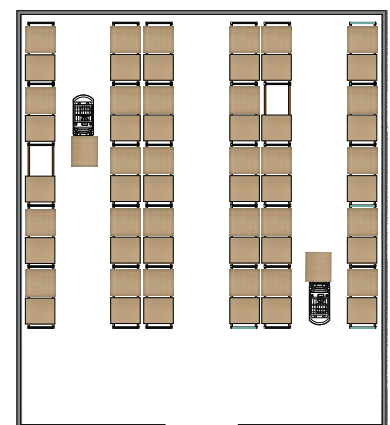

Typical Selective floorplan



Frames

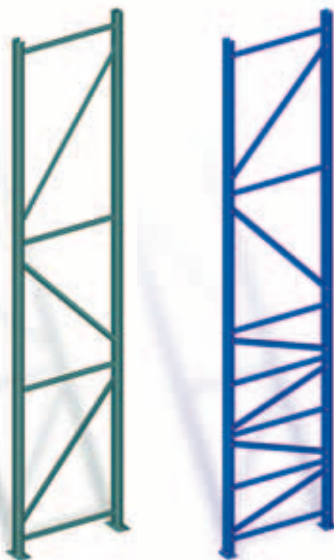

Standard frames consist of two posts, horizontal and diagonal struts, and foot plates. Hole punches for beam insertion are placed along the post in 2" intervals. Posts are available in a variety of gauges, lengths, configurations for seismic zones and bracing patterns made to be more resistant to twisting, separating and axial loading.

The capacities shown are:

- Applicable for non-seismic use only
- Shown in pounds (lbs) and for product load plus dead load (dead load = 2.0% of product load)
- Only valid when used with Interlake Mecalux published beam sizes
- Accurate for static loads only

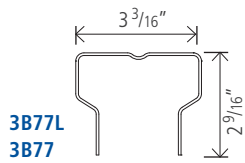

**3B80
3B81
3B82**

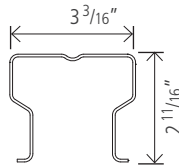

**4B101
4B102**

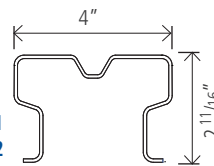

5B122

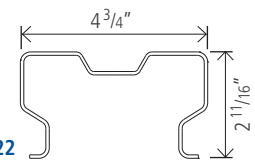

BOLTED FRAME CAPACITIES (lbs)

Model	3B77L (60" - 144")	3B77 (146" - 192")	3B80	3B81	3B82	4B101	4B102	5B122
Gauge	15 GA (0.067")	15 GA (0.067")	14 GA (0.070")	13 GA (0.090")	12 GA (0.105")	13 GA (0.090")	12 GA (0.105")	12 GA (0.105")
Maximum Unsupported Span (HbL)								
36"	18,000	21,000	26,400	33,000	37,500	41,100	48,500	55,600
48"	15,700	18,100	22,700	28,200	32,300	37,300	44,000	52,000
60"	13,100	15,000	18,700	23,100	26,700	33,000	38,800	47,600
72"	10,400	11,800	14,700	18,000	21,100	28,300	33,300	42,800
84"	8,000	8,000	9,600	13,600	16,000	23,600	27,800	37,600
96"	6,300	6,300	7,700	10,500	12,400	19,200	22,500	32,500
108"	5,100	5,100	6,200	8,300	9,800	15,200	17,900	27,500
120"	4,200	4,200	5,200	6,800	8,000	12,400	14,600	22,700

025

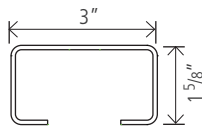

**070
075
077
079**

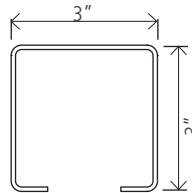

**095
099**

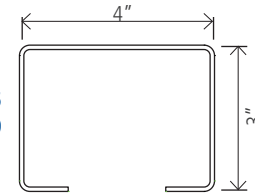

WELDED FRAME CAPACITY (lbs)

Model	025F	070F	075F	077F	079F	095F	099F
Gauge	13 GA(0.090")	14 GA(0.070")	13 GA(0.090")	12 GA(0.105")	11 GA(0.120")	13 GA(0.090")	11 GA(0.120")
Maximum Unsupported Span (HbL)							
36"	23,400	28,600	38,400	44,300	50,000	37,500	60,200
42"	21,900	25,900	34,600	39,800	44,900	37,500	60,200
48"	19,300	23,000	30,600	35,200	39,700	36,300	57,900
54"	16,700	20,000	26,400	30,400	34,300	33,900	53,200
60"	15,000	17,700	23,100	26,600	30,000	31,300	48,400
66"	13,400	16,000	20,900	24,000	27,100	28,500	43,500
72"	11,700	14,400	18,700	21,400	24,100	25,800	38,700
78"	10,300	12,800	16,500	19,000	21,300	23,200	34,500
84"	9,100	11,400	14,700	16,900	19,000	21,700	31,900
90"	8,000	10,200	13,100	15,100	16,900	20,100	29,400
96"	7,100	9,200	11,800	13,500	15,200	18,600	26,800

HbL=Height between Levels

NOTE:

- Capacities are per the 2008 RMI and 2001 AISI specifications.
- Frame capacities shown include product load plus dead load (dead load = 2% of product load).
- Maximum unsupported length is the maximum beam spacing or the distance between the floor and the top of the first beam (whichever is greater).
- Capacities are only valid when used with Interlake Mecalux published beam sizes.
- Capacities are valid for static load only.
- These capacities assume that all component parts are: (1) Manufactured by Interlake Mecalux. (2) In good condition. (3) Properly installed.



Beams

Load beams are roll formed with a 1-5/8" step along the top inside edge for holding load support components such as pallet supports or wire decks. Capacities are for uniformly distributed product load plus dead load per pair of beams (dead load = weight of beams) and are applicable for non-seismic use only.

Slotted and Unslotted Beams

Beams can be slotted on the step ledge at 1" centers as an option. Slots allow the penetration of a fabricated tab to restrict the horizontal movement of a crossbar (pallet support). Due to the manufacturing process, slot cut-off points are random at the end of each beam. All beams receive two solid coats of paint on every surface and are then oven baked.



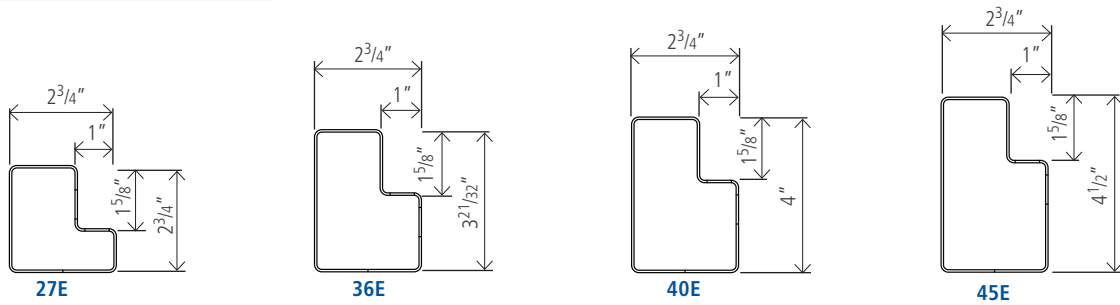

SLOTTED and UNSLOTTED STEP BEAM CAPACITY (lbs per pair)

Span	27E	36E	40E	45E	50E	59E	65E	65Q
48"	5,627	8,510	9,726	11,631	13,684	16,321	20,938	28,095
54"	5,045	7,613	8,691	10,382	12,214	14,553	18,669	25,024
60"	4,581	6,888	7,863	9,393	11,039	13,138	16,854	22,568
66"	4,196	6,302	7,187	8,575	10,067	11,981	15,369	20,558
72"	3,721	5,815	6,623	7,902	9,267	11,017	14,117	18,884
78"	3,203	5,397	6,146	7,326	8,590	10,201	13,072	17,467
84"	2,788	5,044	5,738	6,831	8,010	9,502	12,164	16,269
90"	2,451	4,656	5,385	6,403	7,500	8,897	11,388	15,216
96"	2,175	4,120	5,058	6,036	7,061	8,367	10,699	14,295
102"	1,945	3,674	4,510	5,705	6,674	7,900	10,101	13,468
108"	1,749	3,300	4,046	5,339	6,324	7,485	9,570	12,746
114"	1,585	2,985	3,656	4,818	6,017	7,113	9,085	12,100
120"	1,443	2,710	3,318	4,368	5,615	6,779	8,649	11,519
126"	1,320	2,476	3,027	3,984	5,115	6,477	8,264	10,994
132"	1,214	2,269	2,774	3,651	4,682	6,031	7,694	10,261
138"	1,120	2,091	2,553	3,355	4,303	5,610	7,157	9,562
144"	1,037	1,932	2,358	3,096	3,969	5,233	6,669	8,933
150"	-	-	-	-	3,675	4,897	6,239	8,371
156"	-	-	-	-	3,413	4,584	5,841	7,857
162"	-	-	-	-	3,179	4,302	5,476	7,383
168"	-	-	-	-	2,966	4,051	5,156	6,946

NOTE:

- Capacities are per the 2008 RMI and 2001 AISI specifications.
- Interlake Mecalux beams over 126"L require bracing to prevent buckling.
- Beams longer than 90" that support decking must be tied together to prevent spreading (IK025B crossbar).
- Loading to be uniformly distributed over the length of the beam.
- Values shown reflect the capacity of the beams based on the lesser of its strength in bending, or L/180 deflection criteria.
- Load capacities are for uniformly distributed product load plus dead load per pair of beams (dead load = weight of beams).
- Capacities are valid for static load only.
- These capacities assume that all component parts are: (1) Manufactured by Interlake Mecalux. (2) In good condition. (3) Properly installed.

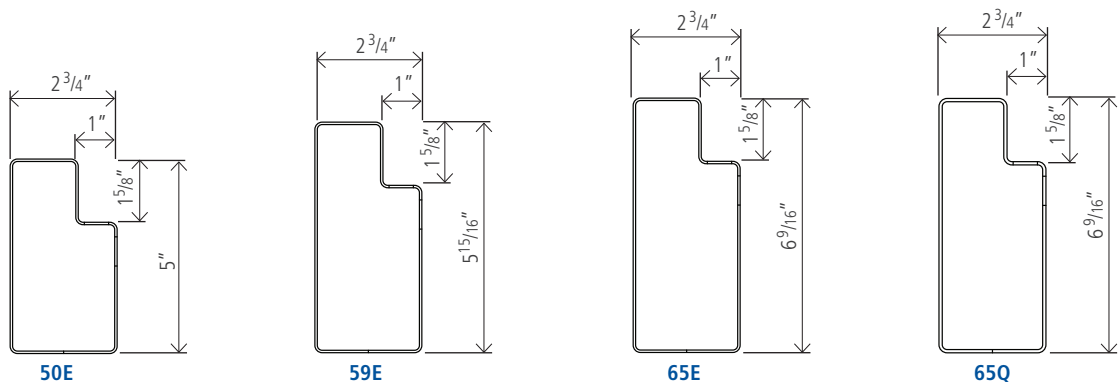

Z Beams

Z beams are a lighter capacity beam designed to support particle board or wire decking. Named "Z" because of the profile, Z beams are used in the construction of picking areas. They are available with a 3-pin tear drop connection to fit securely within a selective bay.

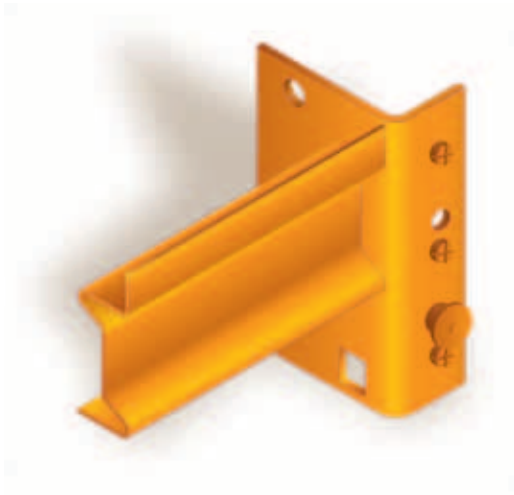

ZS Beams-U65 = 14 ga
For use with wire decking

Z BEAM CAPACITY (lbs per pair)	
Span	ZS-U65
72"	1,985
78"	1,808
84"	1,742
90"	1,654
92"	1,566
96"	1,433



Beam Weld Type Options

Beams are welded to the endplates by AWS certified welding technicians. Under normal, static loading conditions, the "A" weld is sufficient. The end plates are welded to the beam along the front and rear face of the beam edge. For certain seismic loading conditions, "D" welds are also available.

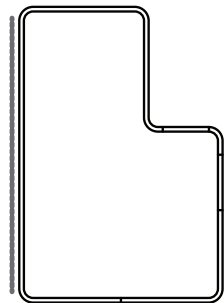

"A" Type Weld

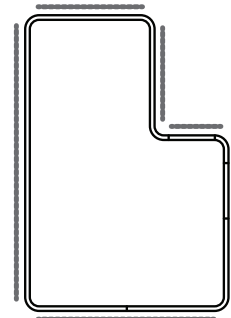

"D" Type Weld



End Plates

The foundation of the Interlake Mecalux selective rack system is the unprecedented beam-to-upright connection offered in the Piston Lock automatic locking device. The stud design and column punching draw tighter together under load to create the industry's most secure connection while maximizing system capacity.

Our proprietary locking system engages automatically upon beam seating, making installation and re-profiling easier while protecting against accidental beam release. The piston lock is damage- and tamper-resistant, and stays snugly in place during use.

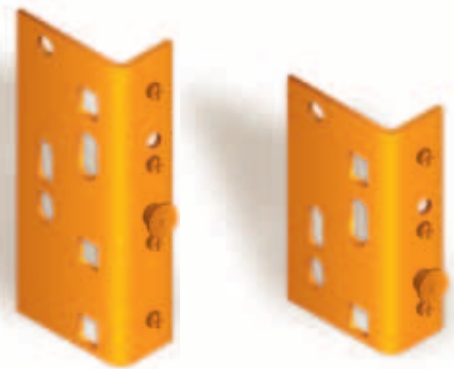

Selective Rack Components

The Interlake Mecalux Selective Pallet Rack system provides an efficient use of floor space, load flexibility and easy reprofiling, all made possible through its extensive range of frame pieces and accessory components.

Welded frames have a powder coat finish in standard green. Bolted frames are painted standard blue with a cathaphoretic paint process.

- 1/ Frame
- 2/ Beam
- 3/ Foot plate
- 4/ Horizontal strut
- 5/ Diagonal strut
- 6/ Shim
- 7/ Bolt on post protector
- 8/ End aisle protector
- 9/ Shelf panel
- 10/ Row spacer
- 11/ Roll-in pallet support
- 12/ Double flanged pallet support
- 13/ Drum/coil bed
- 14/ Fork clearance bar
- 15/ Skid channel
- 16/ Wall tie
- 17/ Drum cradle
- 18/ Corner protector
- 19/ Post protector

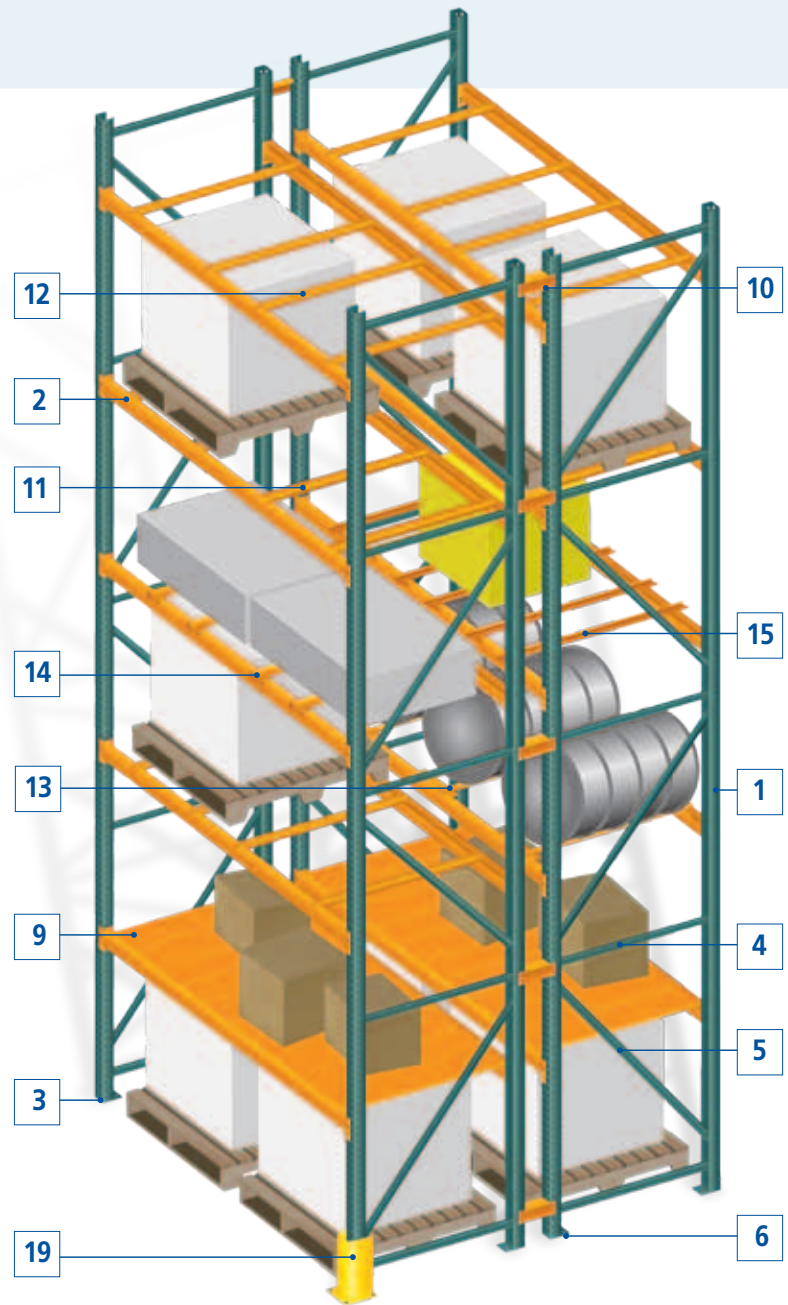

Welded Selective Pallet Rack

Accessories

A variety of accessories are available for Selective Rack systems. From pallet supports to column protectors, Interlake Mecalux has accessories to meet any need. For a complete list of accessories, please contact your Interlake Mecalux representative.

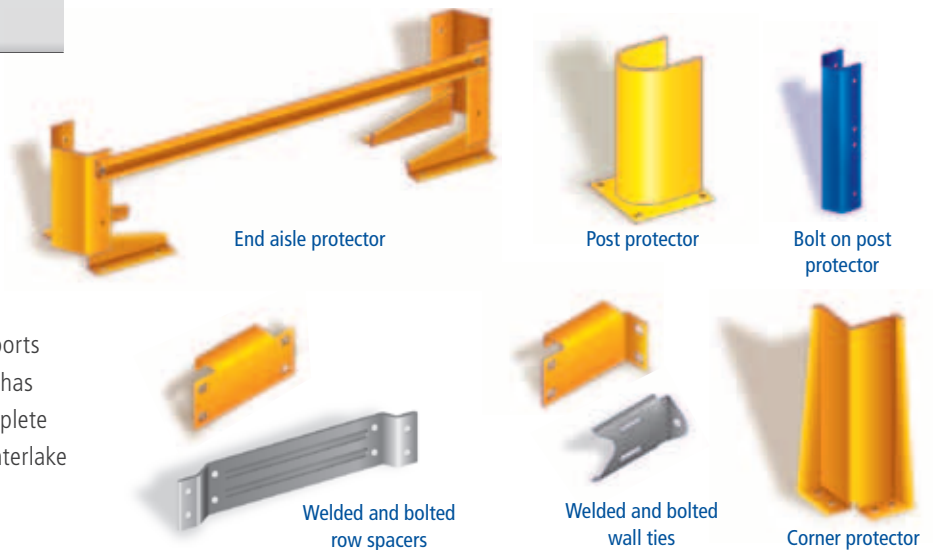

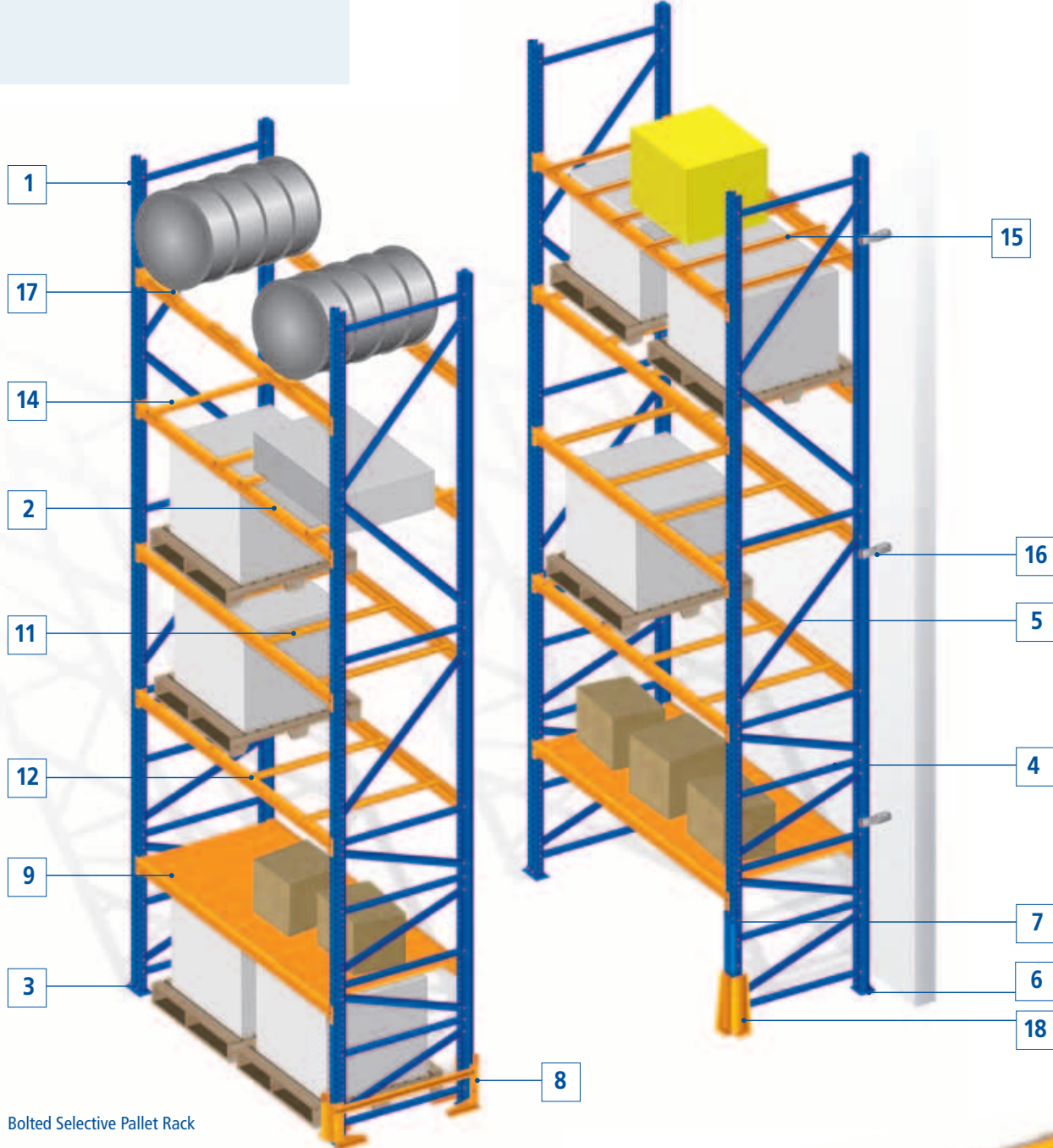

Bolted Selective Pallet Rack



SALES OFFICES

CHICAGO
1600 N. 25th Ave.
Melrose Park, IL 60160
708-344-9999

DALLAS
1520 Selene Drive
Carrollton, TX 75006

SAN DIEGO
8607 Ave de la Fuente
San Diego, CA 92154

PRODUCTION PLANTS

CHICAGO
1600 N. 25th Ave.
Melrose Park, IL 60160

MATAMOROS
Las Rusias 2700, Industrial del Norte
CP 87470 Matamoros,
Tamps, MX

PONTIAC
701 Interlake Drive
Pontiac, IL 61764

SUMTER
1925 Corporate Way
Sumter, SC 29154

TIJUANA
Blvd. Bellas Artes #9001
Ciudad Industrial
Tijuana, Baja California,
MX 22500



info@interlakemecalux.com | www.interlakemecalux.com

1.877.632.2589



OFFICES WORLDWIDE

Argentina, Belgium, Brazil, Canada, Chile,
Czech Republic, France, Germany, Italy, Mexico,
Panama, Peru, Poland, Portugal, Spain, Turkey,
United Kingdom, USA, Uruguay

